

**INSTITUTIONAL MK REGLETTE – ref. 459717**

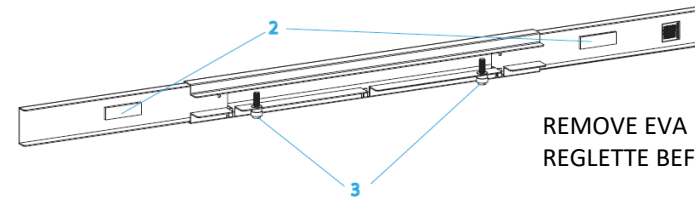
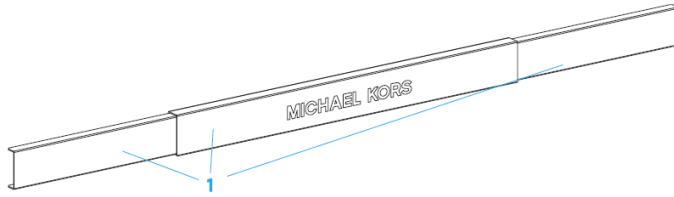

REMOVE EVA PADS FROM  
REGLETTE BEFORE RECYCLING

ONLY FOR ITALY

	ELEMENT	RAW MATERIAL	DISPOSAL SPECIFICATIONS
	1. REGLETTE	STAINLESS STEEL - ♻️ 40	METAL
	2. EVA PADS	EVA - ♻️ 07 0	GENERAL WASTE
	3. TRANSPARENT SCREWS	ACRYLIC - ♻️ 07 0	GENERAL WASTE

For the correct disposal of the product, please check the regulations of your area

**INSTITUTIONAL MK REGLETTE WITH TRAY – ref. 459720**

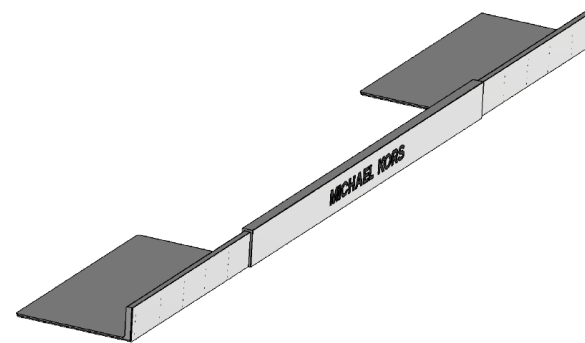

ONLY FOR ITALY



	ELEMENT	RAW MATERIAL	DISPOSAL SPECIFICATIONS
	REGLETTE FRONT	ALLUMINIUM - ♻️ 41 ALU	GENERAL WASTE
	REGLETTE BODY	PLASTIC - ♻️ 07 0	

For the correct disposal of the product, please check the regulations of your area

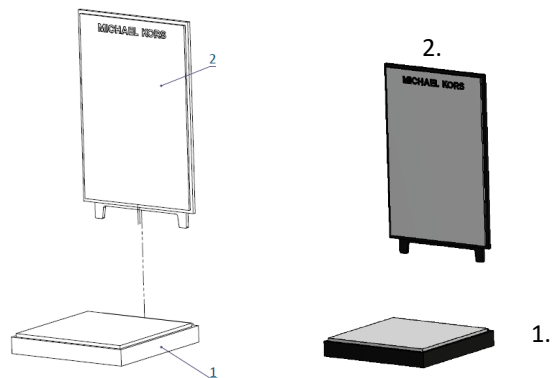
INSTITUTIONAL MK SHELF TESTER – ref. 4597



ONLY FOR ITALY

	ELEMENT	RAW MATERIAL	DISPOSAL SPECIFICATIONS
	1. BASE	PLASTIC - 	GENERAL WASTE
	2. CROWNER	PLASTIC - 	



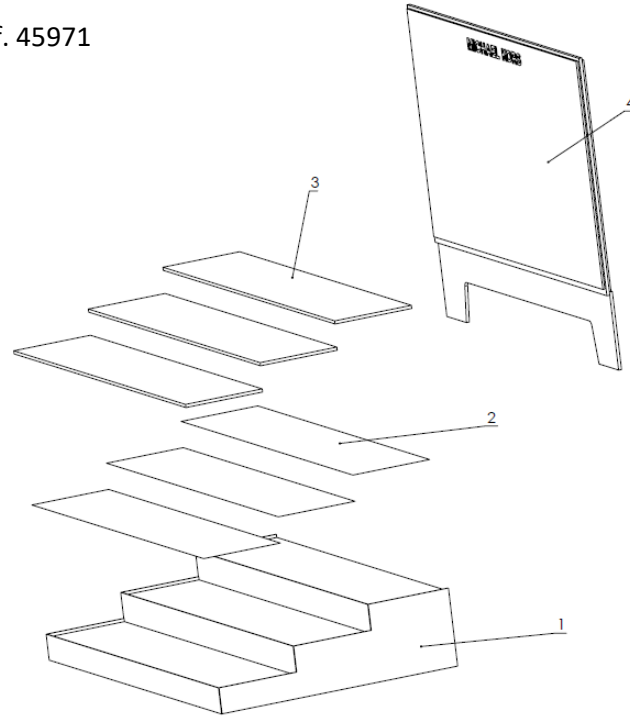

For the correct disposal of the product, please check the regulations of your area

**INSTITUTIONAL MK COUNTER TESTER – ref. 45971**



**ONLY FOR ITALY**



ELEMENT	RAW MATERIAL	DISPOSAL SPECIFICATIONS
1. BASE	ALUMINIUM - 	GENERAL WASTE
	PLASTIC - 	
2. PVC GRAPHIC	PET 01 - 	PLASTIC
3. CLEAR GLASS	GLASS - 	GLASS
4. CROWNER	PLASTIC - 	GENERAL WASTE

For the correct disposal of the product, please check the regulations of your area

ITALY MK MERCHANDISING UNIT – ref. 459725

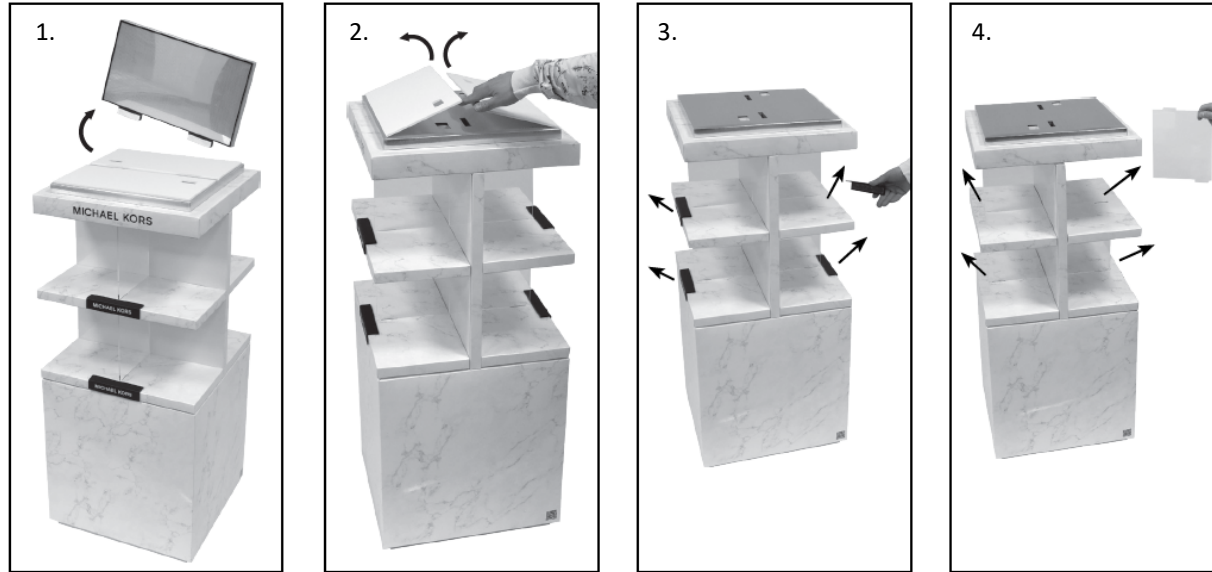

ONLY FOR ITALY







ELEMENT	RAW MATERIAL	DISPOSAL SPECIFICATIONS
1. CROWNER	PAPER – PAP21	GENERAL WASTE
	PLEXIGLASS – 07 OTHER	
2. WHITE TOP	PLEXIGLASS – 07 OTHER	GENERAL WASTE
3. LOGOS	PLEXIGLASS – 07 OTHER	GENERAL WASTE
4. SHELF SUPPORTS	PLEXIGLASS – 07 OTHER	GENERAL WASTE
5. FULL STRUCTURE	PAPER	PAPER

For the correct disposal of the product, please check the regulations of your area

**MK GORGEOUS! SHELF TESTER – ref. 4500189**



**ONLY FOR ITALY**





	ELEMENT	RAW MATERIAL	DISPOSAL SPECIFICATIONS
	1. EXTERNAL CLADDING	PAPER – PAP21 	PAPER
	2. INTERNAL STRUCTURE	CORRUGATED - PAP20 	PAPER
	3. METAL FEET	METAL – FE40 	METAL

For the correct disposal of the product, please check the regulations of your area

**MK GORGEOUS! COUNTER TESTER – ref. 45001A**



**ONLY FOR ITALY**

	ELEMENT	RAW MATERIAL	DISPOSAL SPECIFICATIONS
	1. EXTERNAL CLADDING	PAPER – PAP21 	PAPER
	2. INTERNAL STRUCTURE	CORRUGATED - PAP20 	PAPER
	3. METAL FEET	METAL – FE40 	METAL

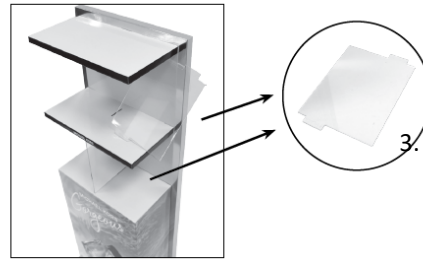

For the correct disposal of the product, please check the regulations of your area

**MK GORGEOUS! MERCHANDISING UNIT – ref. 45006**



**ONLY FOR ITALY**



ELEMENT	RAW MATERIAL	DISPOSAL SPECIFICATIONS
1. EXTERNAL CLADDING	PAPER – PAP21 	PAPER
2. INTERNAL STRUCTURE	CORRUGATED - PAP20 	PAPER
3. PLEXIGLASS	PLEXIGLASS – 07 OTHER 	GENERAL WASTE



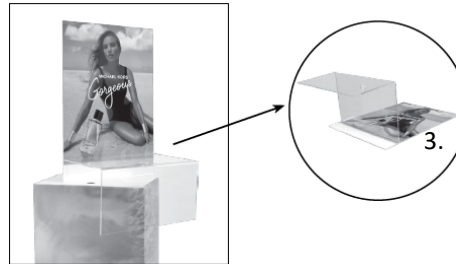

For the correct disposal of the product, please check the regulations of your area

**MK GORGEOUS! FOUNTAIN – ref. 45004**



**ONLY FOR ITALY**







ELEMENT	RAW MATERIAL	DISPOSAL SPECIFICATIONS
1. EXTERNAL CLADDING	PAPER – PAP21 	GENERAL WASTE
2. INTERNAL STRUCTURE	CORRUGATED - PAP20 	
3. PLEXIGLASS	PLEXIGLASS – 07 OTHER 	
4. BASE FOR WEIGHT	WOOD – FOR50 	

For the correct disposal of the product, please check the regulations of your area

**MK GORGEOUS! SHOWCARD** – ref. 4500166



ONLY FOR ITALY

	ELEMENT	RAW MATERIAL	DISPOSAL SPECIFICATIONS
	1. EXTERNAL CLADDING	PAPER – PAP21 	PAPER
	2. INTERNAL STRUCTURE	CORRUGATED - PAP20 	PAPER
	3. METAL FEET	METAL – FE40 	METAL

For the correct disposal of the product, please check the regulations of your area

**MK GORGEOUS! WINDOW** – ref. 45005

ONLY FOR ITALY





	ELEMENT	RAW MATERIAL	DISPOSAL SPECIFICATIONS
	1. EXTERNAL CLADDING	PAPER – PAP21 	PAPER
	2. INTERNAL STRUCTURE	CORRUGATED - PAP20 	PAPER

For the correct disposal of the product, please check the regulations of your area

**MK POUR FEMME SHELF TESTER – ref. 450489**  
**MK POUR HOMME SHELF TESTER – ref. 450389**



**ONLY FOR ITALY**





	ELEMENT	RAW MATERIAL	DISPOSAL SPECIFICATIONS
 	1. EXTERNAL CLADDING	PAPER – PAP21 	PAPER
	2. INTERNAL STRUCTURE	CORRUGATED - PAP20 	PAPER
	3. METAL FEET	METAL – FE40 	METAL

For the correct disposal of the product, please check the regulations of your area

**MK POUR FEMME & POUR HOMME COUNTER TESTER – ref. 45971B**



**ONLY FOR ITALY**

	ELEMENT	RAW MATERIAL	DISPOSAL SPECIFICATIONS
	1. EXTERNAL CLADDING	PAPER – PAP21 	PAPER
	2. INTERNAL STRUCTURE	CORRUGATED - PAP20 	PAPER
	3. METAL FEET	METAL – FE40 	METAL

For the correct disposal of the product, please check the regulations of your area



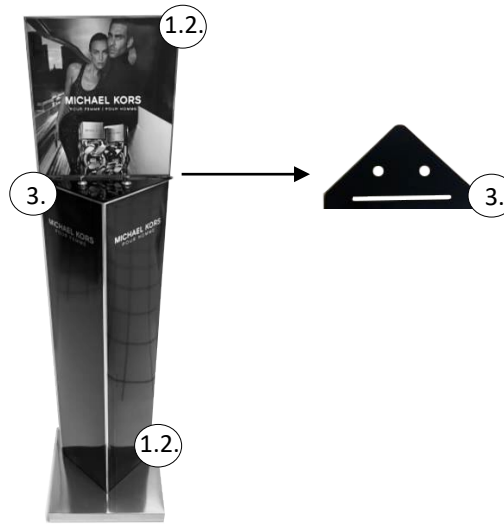

**MK POUR FEMME & POUR HOMME FOUNTAIN – ref. 45974**



**ONLY FOR ITALY**





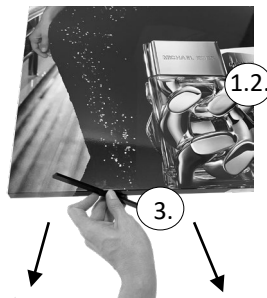

ELEMENT	RAW MATERIAL	DISPOSAL SPECIFICATIONS
1. EXTERNAL CLADDING	PAPER – PAP21 	PAPER
2. INTERNAL STRUCTURE	CORRUGATED - PAP20 	PAPER
3. PLEXI TRAY	PLEXIGLASS – 07 OTHER 	PLASTIC

For the correct disposal of the product, please check the regulations of your area

**MK POUR FEMME & POUR HOMME SHOWCARD – ref. 459766B**



**ONLY FOR ITALY**



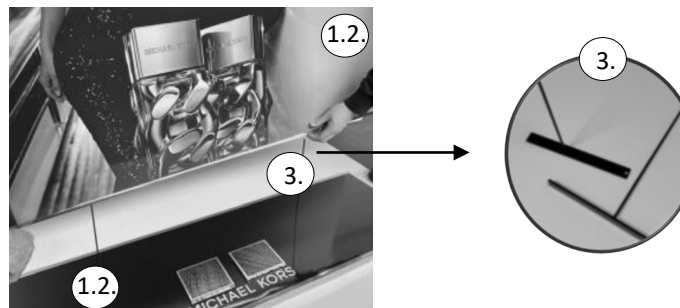

	ELEMENT	RAW MATERIAL	DISPOSAL SPECIFICATIONS
	1. EXTERNAL CLADDING	PAPER – PAP21 	PAPER
	2. INTERNAL STRUCTURE	CORRUGATED - PAP20 	PAPER
	3. METAL FEET	METAL – FE40 	METAL

For the correct disposal of the product, please check the regulations of your area

**MK POUR FEMME & POUR HOMME LUX WINDOW – ref. 45975**



**ONLY FOR ITALY**

	ELEMENT	RAW MATERIAL	DISPOSAL SPECIFICATIONS
	1. EXTERNAL CLADDING	PAPER – PAP21 	PAPER
	2. INTERNAL STRUCTURE	CORRUGATED - PAP20 	PAPER
	3. METAL FEET	METAL – FE40 	METAL

For the correct disposal of the product, please check the regulations of your area